

**K-25 Hand Spinner**

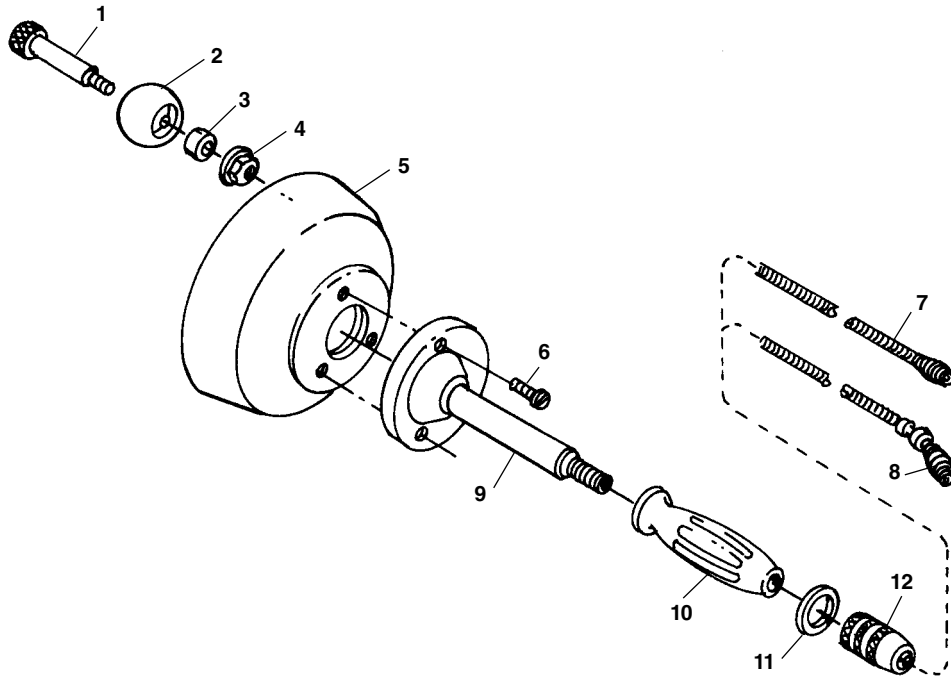

**NOTE: Order parts by Catalog Number only.  
DO NOT order by Reference Number.**

Ref. No.	Catalog No.	Description
—	58890	K-25 - BP w/C-1-IC
—	58895	K-25 - DH w/C-2-IC
1	50632	Shoulder Screw
2	61745	Knob
3	50642	Spacer
4	27517	Lock Nut
5	50637	Cable Container Assembly (Includes Ref. 1,2,3,4,6)
6	61540	Screw
7	56782	C-1 - IC
8	56787	C-2 - IC
9	60735	Guide Tube & Flange
10	76765	Handle Grip
11	31933	Retaining Ring
12	60720	Chuck

**K-26 Hand Spinner**

Ref. No.	Catalog No.	Description
—	59812	K-26 Hand Spinner
1	62225	C-1
2	60777	Chuck Assembly
3	42580	Retaining Ring (2)
4	60782	Guide Tube Handle Assembly
5	84460	Thrust Washer
6	80205	Thrust Washer
7	27517	Lock Nut
8	60787	Cable Container
9	60060	Washer
10	60792	Knob
11	60797	3/8" x 1 3/4" Shoulder Bolt
12	61447	5/8" - 18 Hex Jam Nut

